

TOP VIEW

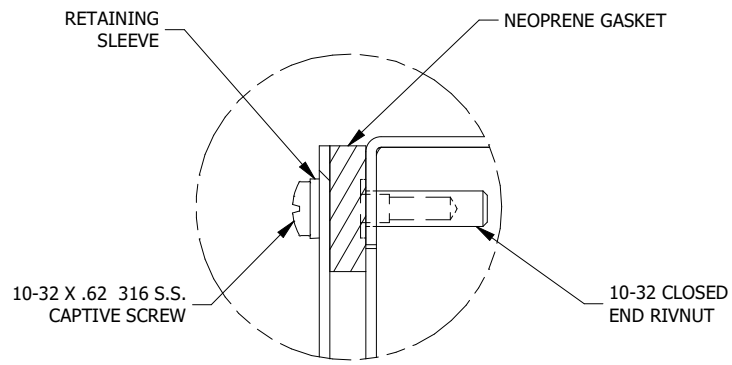

DETAIL A (12 PL.)
(LID INSTALL DETAIL)

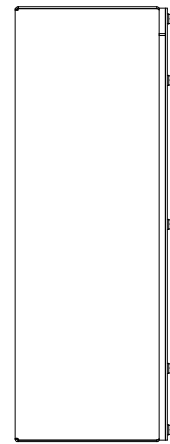

LEFT SIDE VIEW

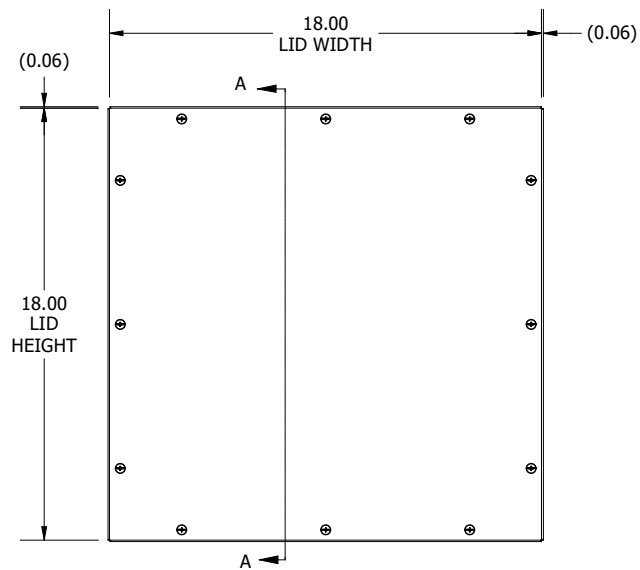

FRONT VIEW

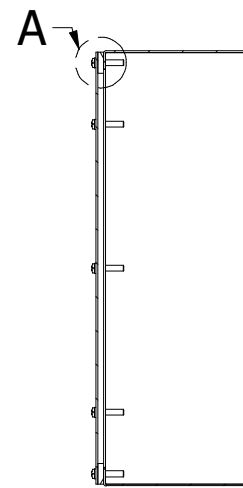

SECTION A-A
(INSIDE LEFT OF ENCL.)

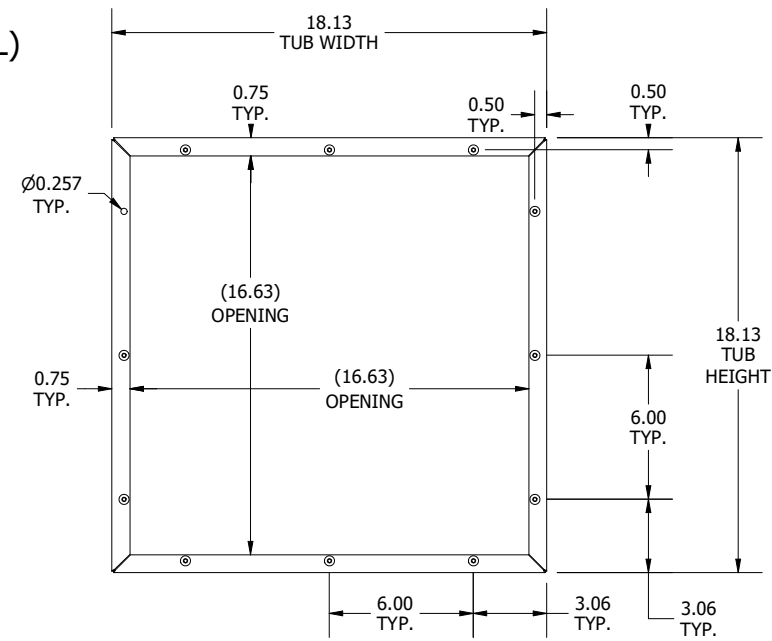

FRONT VIEW
(LID AND (1) RIVNUT REMOVED)

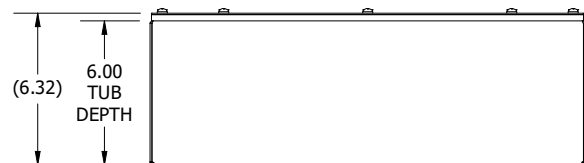
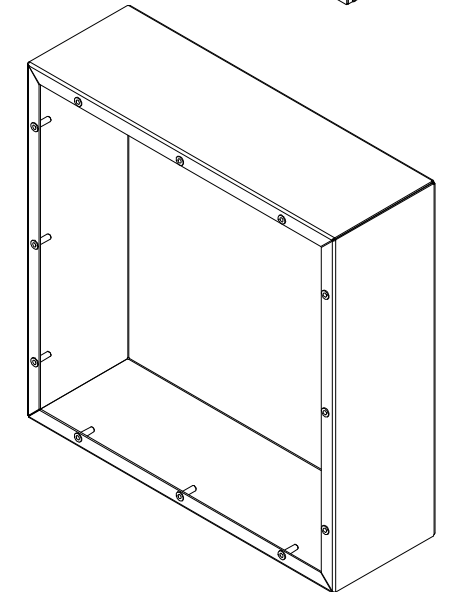
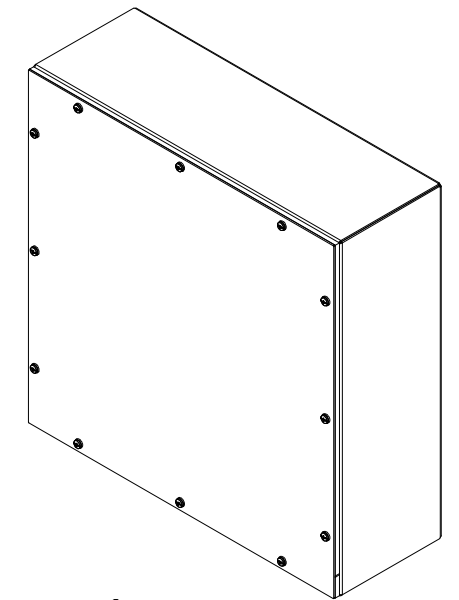

BOTTOM VIEW

PART #:WA181806GSCSSA
 (DATA SUBJECT TO CHANGE WITHOUT NOTICE)
 THIS DRAWING IS THE PROPERTY OF HUBBELL INC. WIEGMANN
 ALL INFORMATION IS PROPRIETARY AND NOT TO BE DUPLICATED